

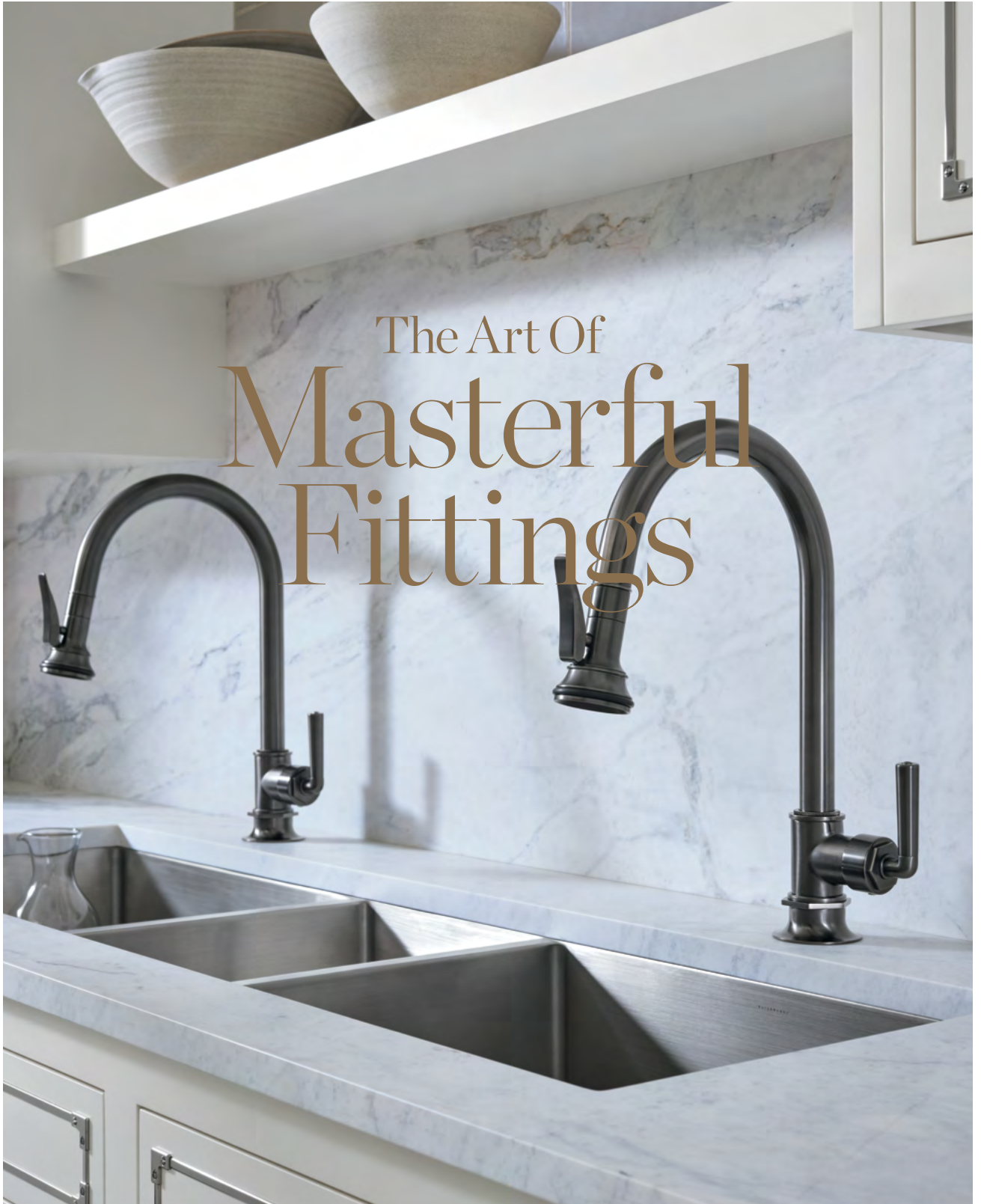

ESTB. 1978

WATERWORKS

The Art Of
Masterful
Fittings





“Exceptional rooms are your legacy.
We design the most beautiful fittings in
the world to help you create them.”

Pet

Peter Sallick
CEO & Creative Director

A FITTING STORY



When you see the world's most inspiring homes, you invariably find Waterworks in the mix. For more than 40 years, our fittings have elevated the bath and kitchen experience, transforming these spaces into alluring environments.

In addition to fittings, we offer fixtures, surfaces, lighting, hardware and accessories to complete your bath or kitchen project—all curated from our single design perspective to create a cohesive, yet layered look.



“No one else asks us to produce fittings like this—using time-honored techniques to get each detail just right and turn out something exceptional. It’s a joy to work this way.”

FAMILY-OWNED BOUTIQUE FACTORY
PIEDMONT REGION, NORTHERN ITALY



“We want our guests to really experience luxury and Waterworks products are a big part of that—each fitting is nothing short of remarkable.”

FOUR SEASONS HOTEL AT THE SURF CLUB
SURFSIDE, FL

PHOTOGRAPHY: CHRISTIAN HORAN PHOTOGRAPHY

i.

Fittings: Bath & Kitchen

For The Kitchen | pg. 10

For The Bath | pg. 19

Henry Collection: Unexpectedly Familiar | pg. 26

ii.

A Firm Promise

Design Authenticity & Quality Craftsmanship | pg. 38

Expert Engineering & Genuine Materials | pg. 43

iii.

Metal Finishes

The World Of Metal Finishes | pg. 46

iv.

Design Resources

At Your Service | pg. 56

Visit Us | pg. 59



FITTINGS:

BATH

&

KITCHEN

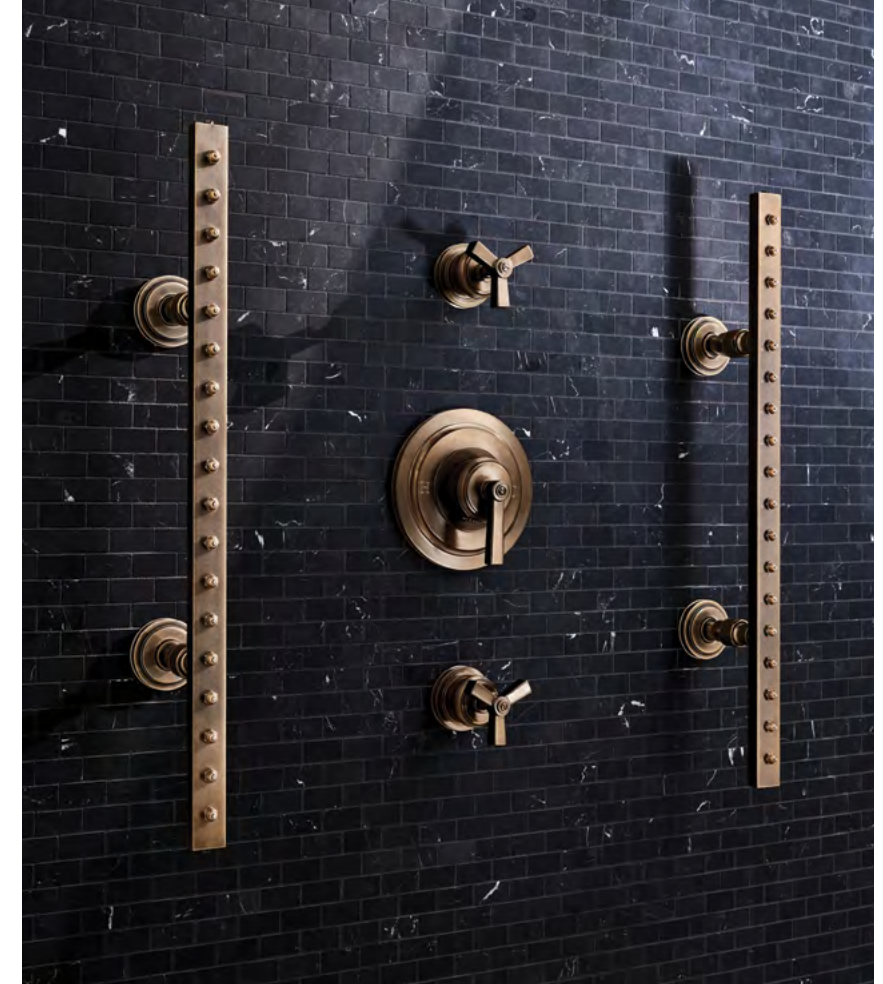

Among the most uniquely tactile elements of the bath and kitchen, your fittings selection should be thoughtfully considered. Touched multiple times a day, they should be elegant and powerful and without compromise. Our authentic designs are made of 100% brass, creating a feel and strength unlike any other.

Projects range from modern to traditional, from organic to industrial, each with its own unique inspiration and vision. Whatever your aesthetic, our stunning assortment provides the most sophisticated and finely crafted option for your space.

For The KITCHEN

Our fittings add dimension in beautiful and unexpected ways. From traditional four hole spreads to single hole faucets with integrated pull sprays, each fitting is designed, engineered and crafted without compromise. Form and function live in parallel for a stunning and effortless experience.



The classic draft beer tap, reinterpreted to create a beautiful experience in water delivery. ON TAP is a statement-maker in any setting.

ON TAP KITCHEN FAUCET WITH SIDE SPRAY | UNIVERSAL WATER DISPENSER



FORMWORK KITCHEN FAUCET WITH SIDE SPRAY

Sculptural forms that defy the ordinary. FORMWORK epitomizes modern minimalism with an unexpected warmth.



REGULATOR BAR FAUCET | REGULATOR POT FILLER

Rugged and large-scale, our REGULATOR fittings reference industrial controls from the early 20th century.



FORO KITCHEN FAUCET WITH INTEGRATED PULL SPRAY

A twist on classic design, FORO mixes historical references to create a wonderfully elegant formal statement. Beautifully crafted, each FORO lever handle features 20 intricately engraved lines.



ON TAP KITCHEN FAUCET WITH SIDE SPRAY



R.W. ATLAS BAR FAUCET



For The BATH

Bathrooms are the most intimate spaces in the home—a retreat from the rest of the world. Whether you're designing an indulgent primary suite, a welcoming guest bath or a statement-making powder room, our fittings have the power to transform.



.25 LAVATORY FAUCET

The most minimal faucet anywhere.
The perfect quarter turn radius of .25 makes
a naturally ergonomic design statement.

Hand-engraved in Italy, this BOND faucet
features an intricate guilloche links pattern—a
technique dating back to the 17th century that
few skilled artisans in the world can create.

BOND UNION SERIES LAVATORY FAUCET WITH GUILLOCHE LINK LEVER HANDLES





HENRY LAVATORY FAUCET

With their pronounced hexagonal nuts and coin-edge rings, HENRY fittings look familiar yet entirely original and modern.



R.W. ATLAS EXPOSED THERMOSTATIC SYSTEM

R.W. ATLAS is a groundbreaking industrial-inspired design that nods to precision-crafted goods from the past, from early microscopes to vintage cameras.



FORO TUB FILLER WITH HANDSHOWER



BOULEVARD LAVATORY FAUCET WITH CRYSTAL LEVER HANDLES

Unexpectedly Familiar HENRY

Always perfect. That's the magic of our Henry collection. For its design, we were inspired by some of Manhattan's most inviting restaurants and the chic, yet warm feeling they engender. To capture this subtle experience, we married artistic and industrial references—creating an iconic collection that projects a nuanced modernist restraint.





DESIGN: AMBER INTERIORS
PHOTOGRAPHY: JESS ISAAC

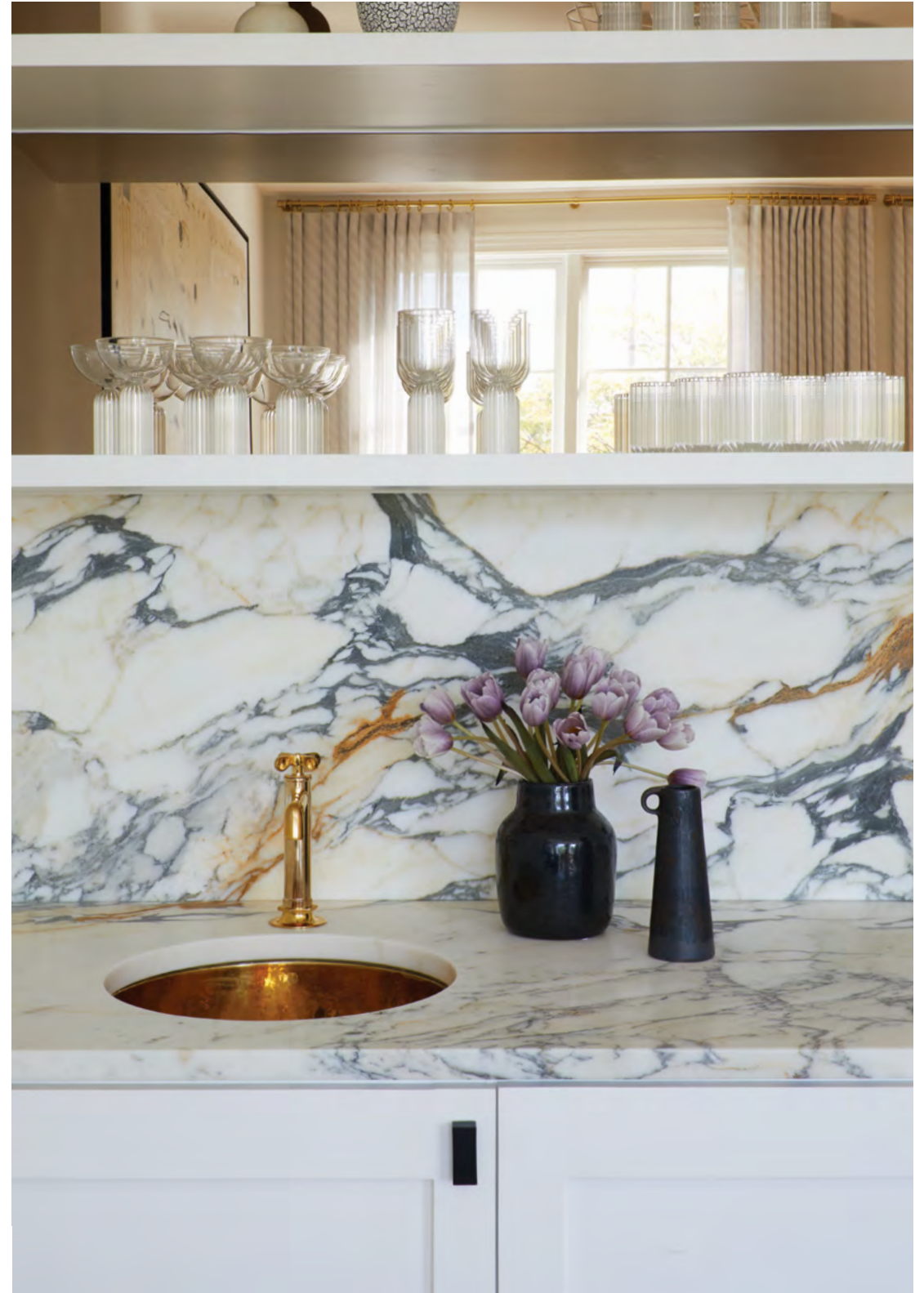

DESIGN: GRISORO STUDIO
PHOTOGRAPHY: KIRSTEN FRANCIS PHOTOGRAPHY



DESIGN: LISA STATON INTERIOR DESIGN
PHOTOGRAPHY: JORDYN PRUITT

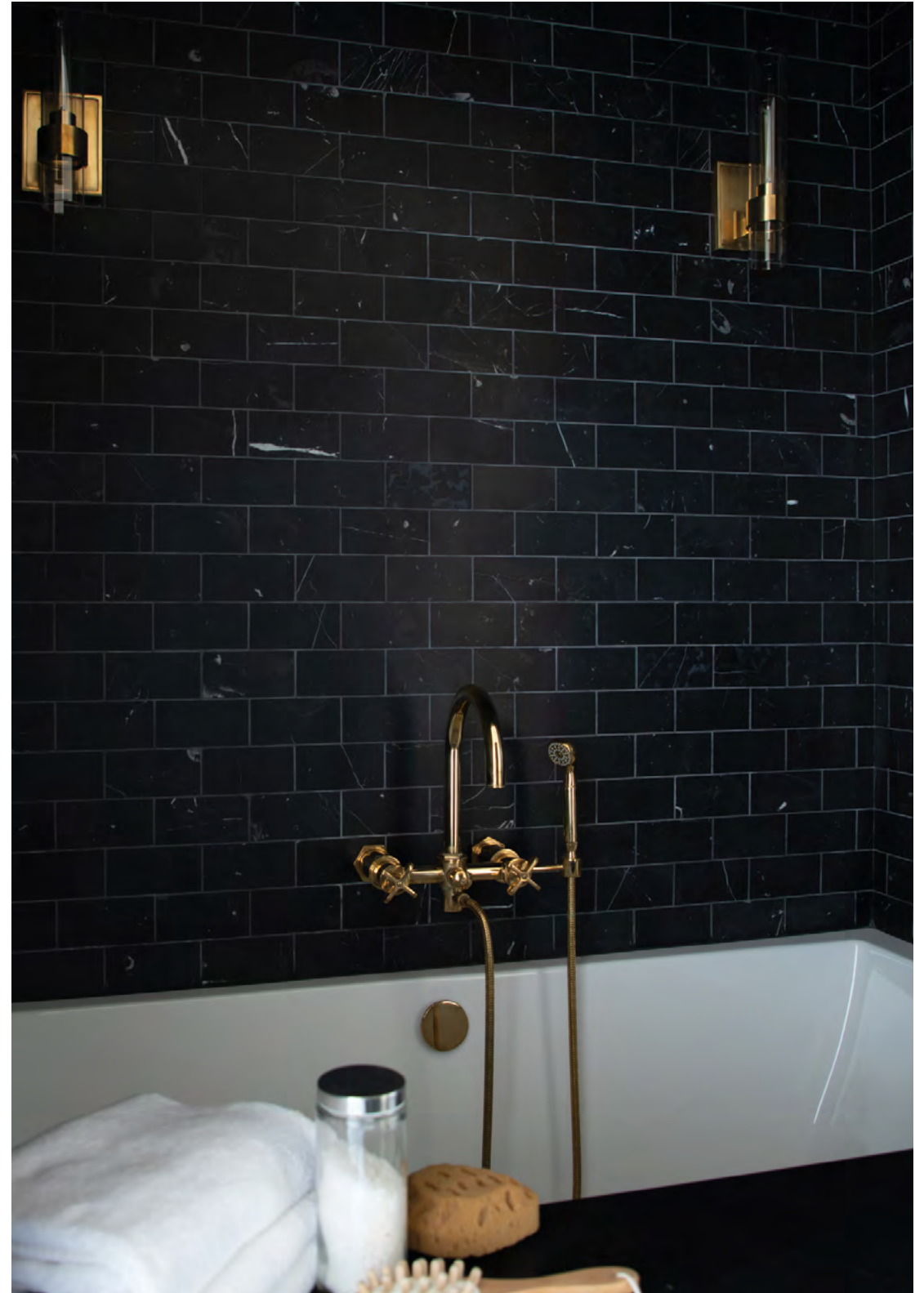

DESIGN: BROOKE GARDNER INTERIOR DESIGN
PHOTOGRAPHY: BROOKE GARDNER



DESIGN: JENNIFER ROBIN INTERIORS
PHOTOGRAPHY: PAUL DYER PHOTOGRAPHY



DESIGN: NICOLE HOGARTY DESIGNS
PHOTOGRAPHY: MICHAEL J. LEE PHOTOGRAPHY



DESIGN: HSH INTERIORS
PHOTOGRAPHY: JOHN MERKL

Henry easily transitions between modern, traditional, utilitarian and classic settings. Bauhaus simplicity meets straightforward American ingenuity, with pronounced hexagonal nuts and coin-edge rings layered onto perfectly balanced sculptural forms. It is familiar, extremely versatile, yet entirely original.

Fresh and inherently fluid, Henry imbues environments with unforced grace.

II.

A

FIRM

PROMISE



Our mission has remained steadfast: to elevate every facet of the bath and kitchen experience. We do this by staying true to the values that guide everything we do—design authenticity, expert engineering, quality craftsmanship and genuine materials.

Passion, deep expertise and integrity drive the creation of enduring, beautifully crafted fittings.

Design Authenticity is the soul of our company.

We create distinctive and original collections that add an element of artistry to any bath or kitchen environment. Each design is unlike any other and every detail is perfected until it represents the best in purposeful design.

Our fittings are designed in-house or in close partnership with a select group of sophisticated collaborators. An expert understanding of design history, engineering and fabrication processes are fully integrated into our approach, rendering truly genuine designs.

We believe in Quality Craftsmanship.

It runs through our entire company and lies at the essence of what we do. Much like revered furniture or an iconic timepiece, superior craftsmanship is at the heart of beautifully crafted fittings.

After designing these special objects and adding performance through engineering, we partner with skilled artisans from around the globe who have practiced their art for generations.



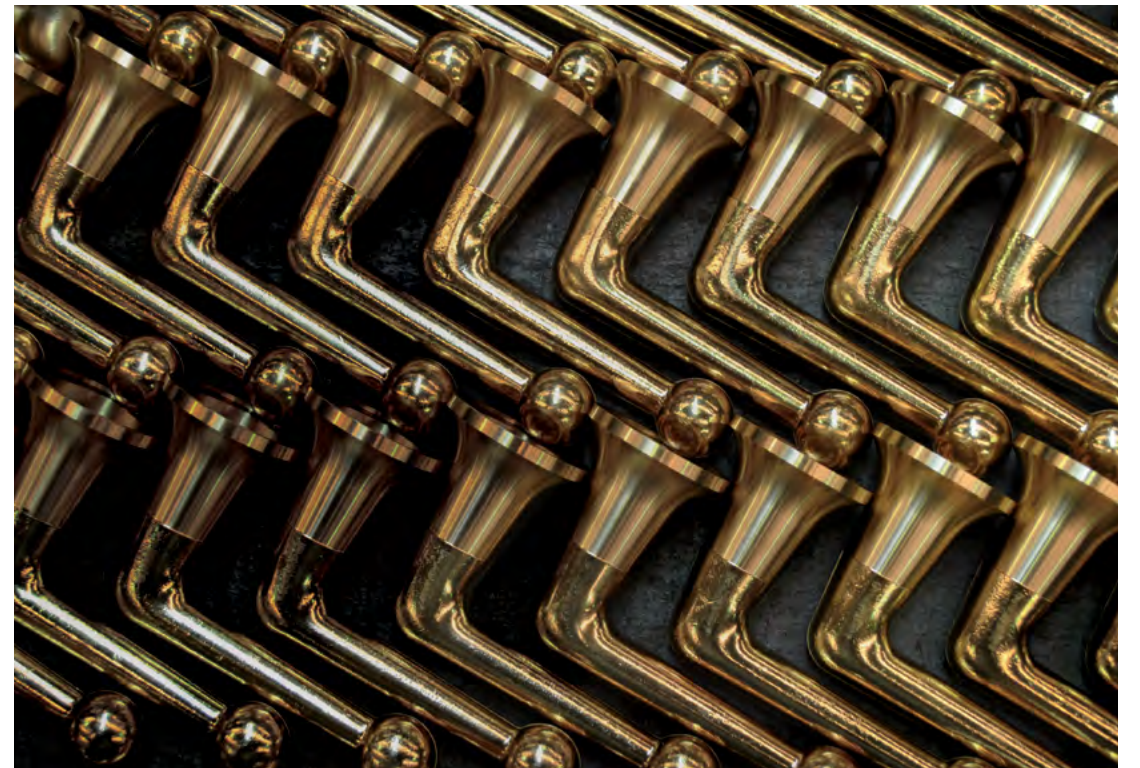
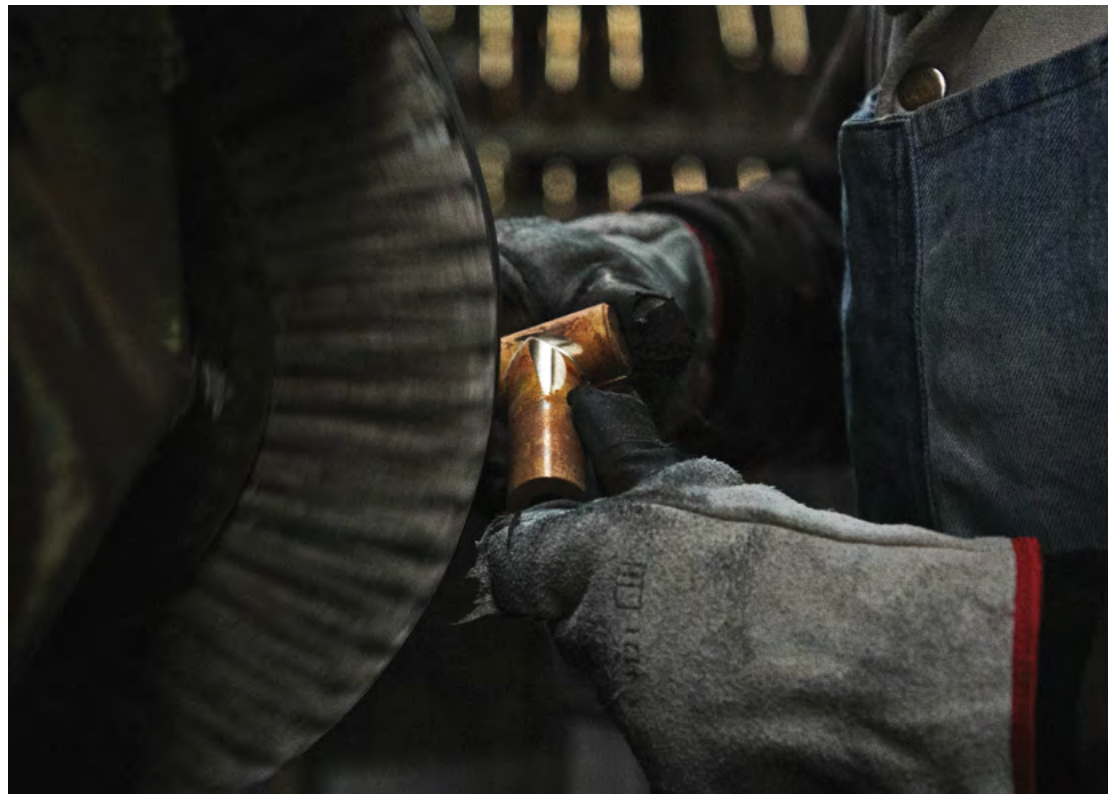
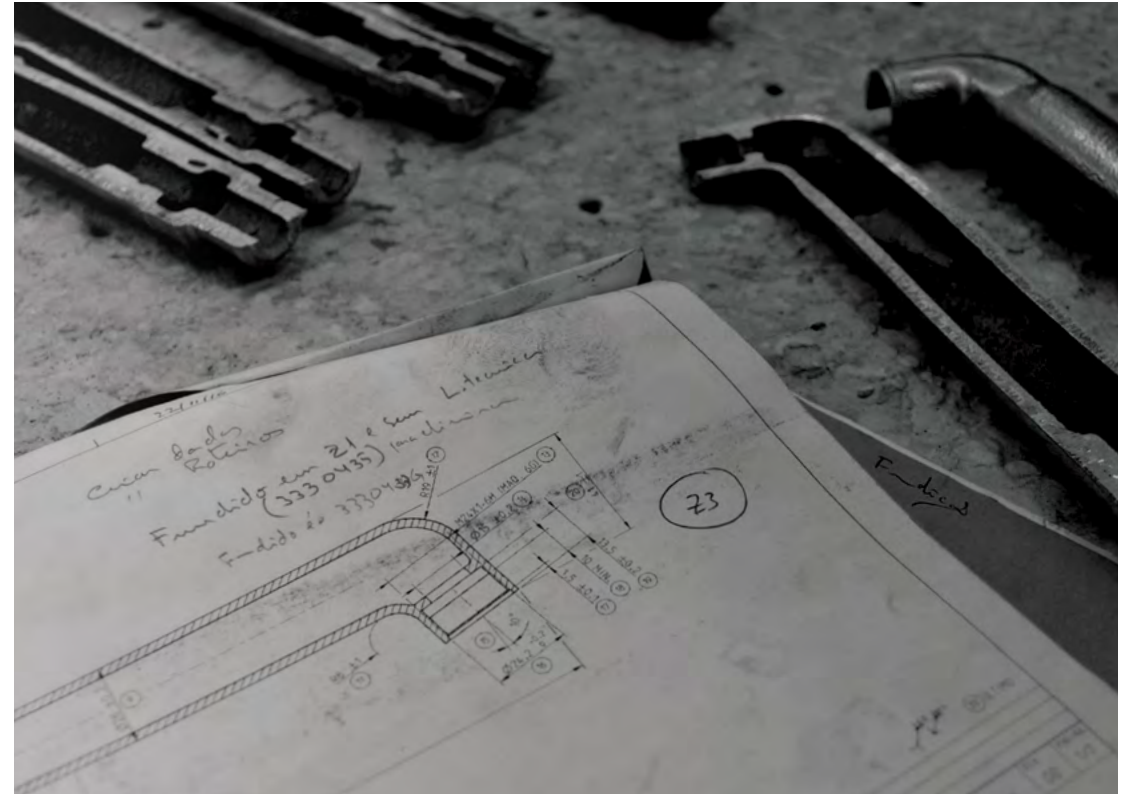
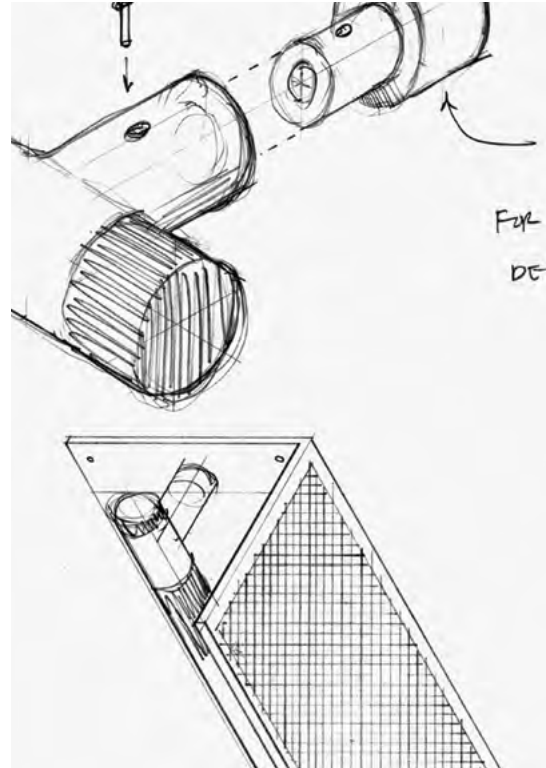



We have a passion for Expert Engineering.

It's the science that elevates our art. Our in-house engineers take design sketches and transform them into mechanical objects that perform beautifully for decades. Combining innovation and incredible technical expertise make Waterworks fittings the benchmark for excellence.

We consider every nuance and plan a manufacturing process to create each element. It's one way we strive for our own level of perfection: making art functional and ensuring lasting quality.

We begin with Genuine Materials.

From the brass that's poured in artisanal factories to impeccable metal finishes that only get better with age. Authentic and extraordinarily durable, they create moments of beauty every time you look at or use them. We choose our materials not just for their strength and aesthetic perfection, but for how they feel in your hand and evolve over time.

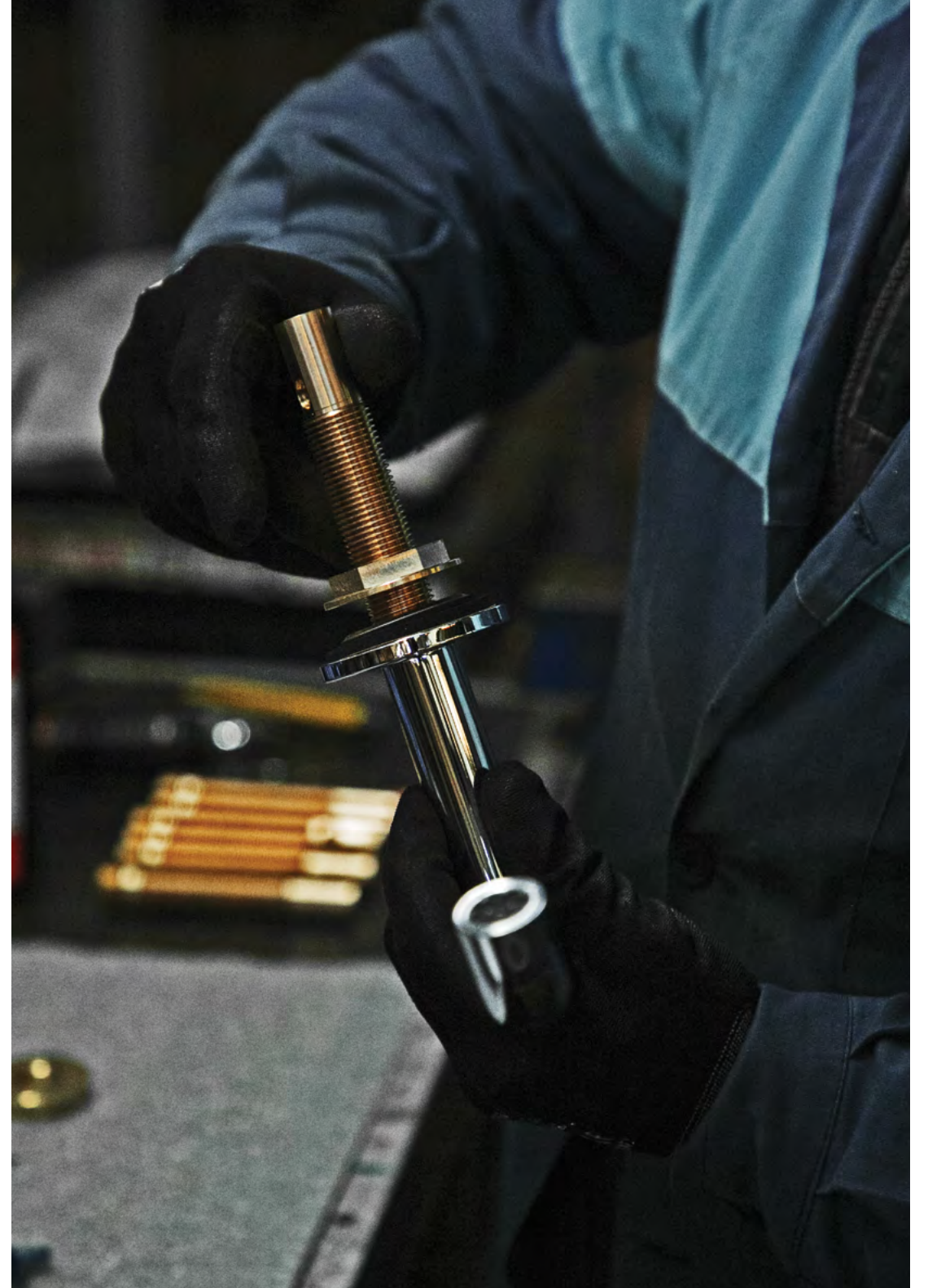
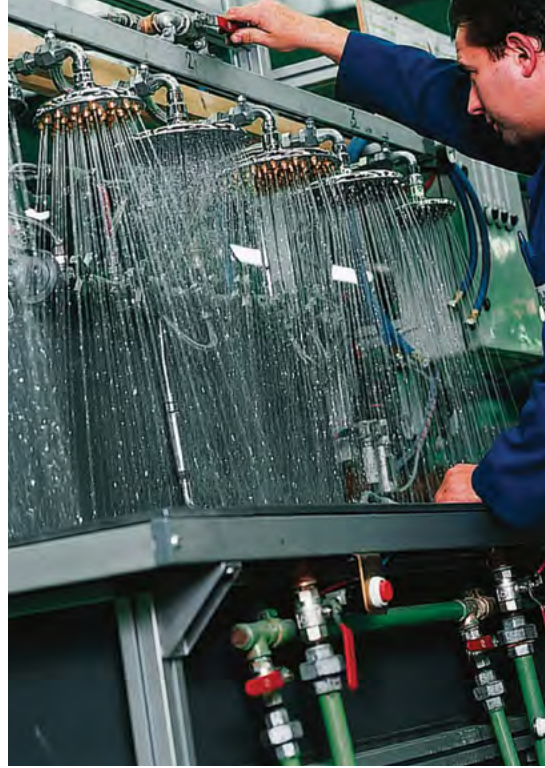

III.

THE WORLD OF METAL FINISHES



Four decades of experience have led us to create our definitive collection of metal finishes. With choices that are designed to look beautiful individually or intermingled, our intelligent system works effortlessly throughout any space.

We offer only authentic, long-lasting metal finishes of the highest quality—each vetted through experience and our discerning lens.

The World Of NICKEL

III. THE WORLD OF METAL FINISHES



NICKEL

A warm, luminous metal that elevates all styles of design, making them feel richer and more sophisticated. Over time, it assumes a slightly deeper tone.



BURNISHED NICKEL

A softly reflective gray finish with beautiful highlights. Hand-burnished with a light touch that preserves detail and brightness.



MATTE NICKEL

An elegant matte gray with visible brush lines, this finish eliminates reflection, creating a tonal experience that works in classic to modern environments.



DARK NICKEL

A rich, sophisticated finish that recalls luxury timepieces and fine jewelry, developed exclusively for Waterworks.

The World Of BRASS

III. THE WORLD OF METAL FINISHES



BRASS

Traditional, nostalgic and a design market favorite, brass patinates over time, taking on lush texture and color variations that make each piece unique.



BURNISHED BRASS

An exclusive hand-burnished process gives this warm finish a velvety gleam. With age, its honeyed hues turn a deeper golden-brown.



VINTAGE BRASS

A lustrous metal tempered by subtly darker tones. Sophisticated and supremely versatile, it patinates to a mellow heirloom effect, having had a head start with our proprietary process.

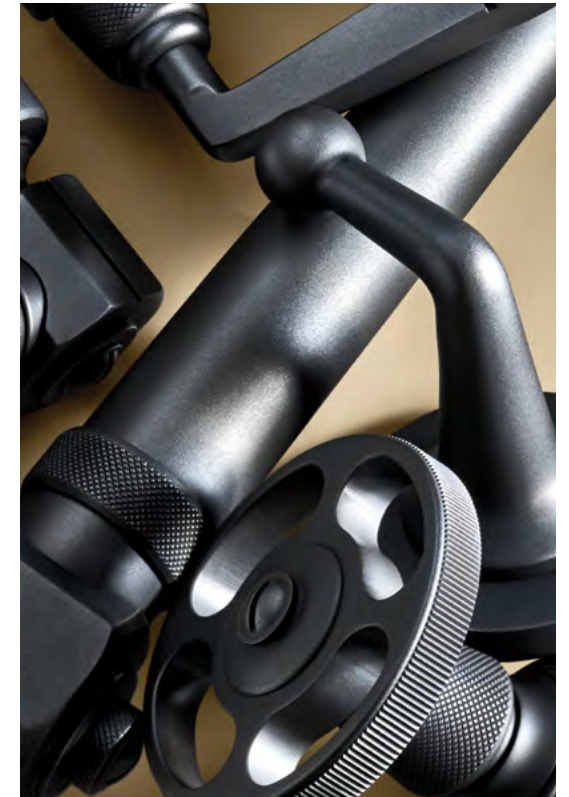

DARK BRASS

An oxidized, dark, earth-toned finish with subtle highlights for depth and character. With use, richer, brighter hints of brass emerge.

The World Of ELEMENTAL

III. THE WORLD OF METAL FINISHES



CHROME

An electroplated, durable mirror finish requiring minimal maintenance. Its cool, bright tones have modern and classic appeal.



COPPER

A rosy mirror finish that stands out at installation and is quick to patinate. If desired, its original brilliance is also easy to maintain.



GOLD

The warm color and highly reflective quality of gold make a lavish statement. Reminiscent of fine jewelry, it's perfect for enlivening a traditional scheme.



MATTE GOLD

A traditional, hand-burnished surface with visible brush lines and the soft gleam of gold bars. Its subtle richness imbues rooms with a warm, luxe feel.

The World Of MIXED METAL

Mixed metals allow for a new level of design detail, unifying finishes in a space while adding a layer of intrigue.



At Your SERVICE

Everything we do at Waterworks is focused on creating an outstanding experience for our clients, including the world's most discerning designers, architects and homeowners. These close connections keep us on the pulse to deliver great products and exceptional service for projects both large and small.

Design Specialists

Whether you're creating a complete kitchen or bath or simply need advice on finishing touches, our design specialists are here to help. They'll make sure your project runs as smoothly and efficiently as possible—and results in an exceptional one-of-a-kind space.

Technical Support

We tap into decades of practical experience and expertise to give you the most informed and professional service possible. Our expert in-house support teams can guide installations and answer questions over the phone or online.

Trade Program

The Waterworks Trade Program is now available online and helps you stay connected to us when you need it most. An invaluable tool, it offers instant access to visible trade pricing, enhanced services and exclusive opportunities.

Service Excellence

Our service is comprehensive and unparalleled. We can help you with everything from product selection to personalized floor plans and state-of-the-art 3-D cabinetry renderings—and in the case of custom millwork, complete project management from start to finish.

Ready-To-Ship

Complete your project quickly and easily with our hundreds of in-stock products. From fittings to fixtures to surfaces, they're all readily available to help you create your design scheme and carry it out to perfection.

waterworks.com

Our website lets you shop online and find parts and installation information 24/7. View the exquisite details of our fittings through high-definition, 4K-resolution imagery and 360° rotations, and imagine your project coming to life.



VISIT US

Book an in-person or virtual appointment at any of our 52 locations in 6 countries around the globe; find inspiration and shop online at [waterworks.com](https://www.waterworks.com); and for assistance outside our store locations, our direct sales team is here to serve you at 800.899.6757.

For locations, visit [waterworks.com/locations](https://www.waterworks.com/locations).

We invite you to explore our world to
imagine new possibilities for yours.





WATERWORKS.COM